

## High Efficiency LED in Ø 3 mm Tinted Diffused Package

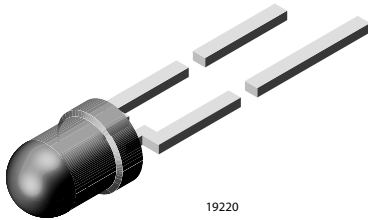

### FEATURES

- Standard Ø 3 (T-1) package
- Small mechanical tolerances
- Suitable for DC and high peak current
- Wide viewing angle
- Luminous intensity categorized
- Yellow and green color categorized
- Compliant to RoHS directive 2002/95/EC and in accordance to WEEE 2002/96/EC



**RoHS**  
COMPLIANT

### DESCRIPTION

The TLH.44.. series was developed for standard applications like general indicating and lighting purposes.

It is housed in a 3 mm tinted diffused plastic package. The wide viewing angle of these devices provides a high on-off contrast.

Several selection types with different luminous intensities are offered. All LEDs are categorized in luminous intensity groups. The green and yellow LEDs are categorized additionally in wavelength groups.

That allows users to assemble LEDs with uniform appearance.

### APPLICATIONS

- Status lights
- Off/on indicator
- Background illumination
- Readout lights
- Maintenance lights
- Legend light

### PRODUCT GROUP AND PACKAGE DATA

- Product group: LED
- Package: 3 mm
- Product series: standard
- Angle of half intensity:  $\pm 30^\circ$

PARTS TABLE		
PART	COLOR, LUMINOUS INTENSITY	TECHNOLOGY
TLHP4401	Pure green, $I_V > 1$ mcd	GaP on GaP
TLHP4401-AS12Z	Pure green, $I_V > 1$ mcd	GaP on GaP
TLHG4400	Green, $I_V > 2.5$ mcd	GaP on GaP
TLHG4401	Green, $I_V > 4$ mcd	GaP on GaP
TLHG4405	Green, $I_V > 6.3$ mcd	GaP on GaP
TLHY4400	Yellow, $I_V > 1.6$ mcd	GaAsP on GaP
TLHY4400-AS12Z	Yellow, $I_V > 1.6$ mcd	GaAsP on GaP
TLHY4400-AS21	Yellow, $I_V > 1.6$ mcd	GaAsP on GaP
TLHY4400-AS21Z	Yellow, $I_V > 1.6$ mcd	GaAsP on GaP
TLHY4400-BT12	Yellow, $I_V > 1.6$ mcd	GaAsP on GaP
TLHY4400-CS12	Yellow, $I_V > 1.6$ mcd	GaAsP on GaP
TLHY4401	Yellow, $I_V > 2.5$ mcd	GaAsP on GaP
TLHY4401-AS12	Yellow, $I_V > 2.5$ mcd	GaAsP on GaP
TLHY4401-AS12Z	Yellow, $I_V > 2.5$ mcd	GaAsP on GaP
TLHY4401-AS21	Yellow, $I_V > 2.5$ mcd	GaAsP on GaP
TLHY4405	Yellow, $I_V > 6.3$ mcd	GaAsP on GaP
TLHY4405-AS12	Yellow, $I_V > 6.3$ mcd	GaAsP on GaP

PARTS TABLE		
TLHY4405-AS12Z	Yellow, $I_V > 6.3$ mcd	GaAsP on GaP
TLHY4405-BT12Z	Yellow, $I_V > 6.3$ mcd	GaAsP on GaP
TLHY4405-MS12	Yellow, $I_V > 6.3$ mcd	GaAsP on GaP
TLHO4400	Soft orange, $I_V > 1.6$ mcd	GaAsP on GaP
TLHO4400_AS12Z	Soft orange, $I_V > 1.6$ mcd	GaAsP on GaP
TLHO4400-MS12Z	Soft orange, $I_V > 1.6$ mcd	GaAsP on GaP
TLHR4400	Red, $I_V > 1.6$ mcd	GaAsP on GaP
TLHR4400-AS12	Red, $I_V > 1.6$ mcd	GaAsP on GaP
TLHR4400-AS12Z	Red, $I_V > 1.6$ mcd	GaAsP on GaP
TLHR4400-AS21Z	Red, $I_V > 1.6$ mcd	GaAsP on GaP
TLHR4400-MS12Z	Red, $I_V > 1.6$ mcd	GaAsP on GaP
TLHR4401	Red, $I_V > 2.5$ mcd	GaAsP on GaP
TLHR4401-AS12Z	Red, $I_V > 2.5$ mcd	GaAsP on GaP
TLHR4401-LS12Z	Red, $I_V > 2.5$ mcd	GaAsP on GaP
TLHR4405	Red, $I_V > 6.3$ mcd	GaAsP on GaP
TLHR4405-AS12	Red, $I_V > 6.3$ mcd	GaAsP on GaP
TLHR4405-AS21	Red, $I_V > 6.3$ mcd	GaAsP on GaP

ABSOLUTE MAXIMUM RATINGS <sup>1)</sup> TLHG440. , TLHO440. , TLHP440. , TLHR440. , TLHY440.				
PARAMETER	TEST CONDITION	SYMBOL	VALUE	UNIT
Reverse voltage		$V_R$	6	V
DC Forward current		$I_F$	30	mA
Surge forward current	$t_p \leq 10 \mu s$	$I_{FSM}$	1	A
Power dissipation	$T_{amb} \leq 60 \text{ }^\circ\text{C}$	$P_V$	100	mW
Junction temperature		$T_j$	100	$^\circ\text{C}$
Operating temperature range		$T_{amb}$	- 40 to + 100	$^\circ\text{C}$
Storage temperature range		$T_{stg}$	- 55 to + 100	$^\circ\text{C}$
Soldering temperature	$t \leq 5$ s, 2 mm from body	$T_{sd}$	260	$^\circ\text{C}$
Thermal resistance junction/ambient		$R_{thJA}$	400	K/W

Note:

<sup>1)</sup>  $T_{amb} = 25 \text{ }^\circ\text{C}$ , unless otherwise specified

OPTICAL AND ELECTRICAL CHARACTERISTICS <sup>1)</sup> TLHR440., RED							
PARAMETER	TEST CONDITION	PART	SYMBOL	MIN.	TYP.	MAX.	UNIT
Luminous intensity <sup>2)</sup>	$I_F = 10$ mA	TLHR4400	$I_V$	1.6	3		mcd
		TLHR4401	$I_V$	2.5	5		mcd
		TLHR4405	$I_V$	6.3	10		mcd
Dominant wavelength	$I_F = 10$ mA		$\lambda_d$	612		625	nm
Peak wavelength	$I_F = 10$ mA		$\lambda_p$		635		nm
Angle of half intensity	$I_F = 10$ mA		$\varphi$		$\pm 30$		deg
Forward voltage	$I_F = 20$ mA		$V_F$		2	3	V
Reverse voltage	$I_R = 10 \mu\text{A}$		$V_R$	6	15		V
Junction capacitance	$V_R = 0$ , $f = 1$ MHz		$C_j$		50		pF

Note:

<sup>1)</sup>  $T_{amb} = 25 \text{ }^\circ\text{C}$ , unless otherwise specified

<sup>2)</sup> In one packing unit  $I_{Vmin.}/I_{Vmax.} \leq 0.5$



OPTICAL AND ELECTRICAL CHARACTERISTICS <sup>1)</sup> TLHO440, SOFT ORANGE							
PARAMETER	TEST CONDITION	PART	SYMBOL	MIN.	TYP.	MAX.	UNIT
Luminous intensity <sup>2)</sup>	$I_F = 10 \text{ mA}$	TLHO4400	$I_V$	1.6	4		mcd
Dominant wavelength	$I_F = 10 \text{ mA}$		$\lambda_d$	598		611	nm
Peak wavelength	$I_F = 10 \text{ mA}$		$\lambda_p$		605		nm
Angle of half intensity	$I_F = 10 \text{ mA}$		$\phi$		$\pm 30$		deg
Forward voltage	$I_F = 20 \text{ mA}$		$V_F$		2.4	3	V
Reverse voltage	$I_R = 10 \mu\text{A}$		$V_R$	6	15		V
Junction capacitance	$V_R = 0, f = 1 \text{ MHz}$		$C_j$		15		pF

Note:

<sup>1)</sup>  $T_{amb} = 25 \text{ }^\circ\text{C}$ , unless otherwise specified

<sup>2)</sup> In one packing unit  $I_{Vmin.}/I_{Vmax.} \leq 0.5$

OPTICAL AND ELECTRICAL CHARACTERISTICS <sup>1)</sup> TLHY440., YELLOW							
PARAMETER	TEST CONDITION	PART	SYMBOL	MIN.	TYP.	MAX.	UNIT
Luminous intensity <sup>2)</sup>	$I_F = 10 \text{ mA}$	TLHY4400	$I_V$	1.6	3		mcd
		TLHY4401	$I_V$	2.5	5		mcd
		TLHY4405	$I_V$	6.3	10		mcd
Dominant wavelength	$I_F = 10 \text{ mA}$		$\lambda_d$	581		594	nm
Peak wavelength	$I_F = 10 \text{ mA}$		$\lambda_p$		585		nm
Angle of half intensity	$I_F = 10 \text{ mA}$		$\phi$		$\pm 30$		deg
Forward voltage	$I_F = 20 \text{ mA}$		$V_F$		2.4	3	V
Reverse voltage	$I_R = 10 \mu\text{A}$		$V_R$	6	15		V
Junction capacitance	$V_R = 0, f = 1 \text{ MHz}$		$C_j$		50		pF

Note:

<sup>1)</sup>  $T_{amb} = 25 \text{ }^\circ\text{C}$ , unless otherwise specified

<sup>2)</sup> In one packing unit  $I_{Vmin.}/I_{Vmax.} \leq 0.5$

OPTICAL AND ELECTRICAL CHARACTERISTICS <sup>1)</sup> TLHG440., GREEN							
PARAMETER	TEST CONDITION	PART	SYMBOL	MIN.	TYP.	MAX.	UNIT
Luminous intensity <sup>2)</sup>	$I_F = 10 \text{ mA}$	TLHG4400	$I_V$	2.5	4		mcd
		TLHG4401	$I_V$	4	6		mcd
		TLHG4405	$I_V$	6.3	12		mcd
Dominant wavelength	$I_F = 10 \text{ mA}$		$\lambda_d$	562		575	nm
Peak wavelength	$I_F = 10 \text{ mA}$		$\lambda_p$		565		nm
Angle of half intensity	$I_F = 10 \text{ mA}$		$\phi$		$\pm 30$		deg
Forward voltage	$I_F = 20 \text{ mA}$		$V_F$		2.4	3	V
Reverse voltage	$I_R = 10 \mu\text{A}$		$V_R$	6	15		V
Junction capacitance	$V_R = 0, f = 1 \text{ MHz}$		$C_j$		50		pF

Note:

<sup>1)</sup>  $T_{amb} = 25 \text{ }^\circ\text{C}$ , unless otherwise specified

<sup>2)</sup> In one packing unit  $I_{Vmin.}/I_{Vmax.} \leq 0.5$

OPTICAL AND ELECTRICAL CHARACTERISTICS <sup>1)</sup> TLHP440., PURE GREEN							
PARAMETER	TEST CONDITION	PART	SYMBOL	MIN.	TYP.	MAX.	UNIT
Luminous intensity <sup>2)</sup>	$I_F = 10 \text{ mA}$	TLHP4401	$I_V$	1	3		mcd
Dominant wavelength	$I_F = 10 \text{ mA}$		$\lambda_d$	555		565	nm
Peak wavelength	$I_F = 10 \text{ mA}$		$\lambda_p$		555		nm
Angle of half intensity	$I_F = 10 \text{ mA}$		$\phi$		$\pm 30$		deg
Forward voltage	$I_F = 20 \text{ mA}$		$V_F$		2.4	3	V
Reverse voltage	$I_R = 10 \mu\text{A}$		$V_R$	6	15		V
Junction capacitance	$V_R = 0, f = 1 \text{ MHz}$		$C_j$		50		pF

Note:

<sup>1)</sup>  $T_{amb} = 25 \text{ }^\circ\text{C}$ , unless otherwise specified

<sup>2)</sup> In one packing unit  $I_{Vmin.}/I_{Vmax.} \leq 0.5$

LUMINOUS INTENSITY CLASSIFICATION		
GROUP STANDARD	LIGHT INTENSITY (mcd)	
	MIN.	MAX.
L	1	2
M	1.6	3.2
N	2.5	5
P	4	8
Q	6.3	12.5
R	10	20
S	16	32
T	25	50
U	40	80

Note:

Luminous intensity is tested at a current pulse duration of 25 ms and an accuracy of  $\pm 11 \%$ .

The above type numbers represent the order groups which include only a few brightness groups. Only one group will be shipped on each bag (there will be no mixing of two groups on each bag).

In order to ensure availability, single brightness groups will not be orderable.

In a similar manner for colors where wavelength groups are measured and binned, single wavelength groups will be shipped on any one bag. In order to ensure availability, single wavelength groups will not be orderable.

### TYPICAL CHARACTERISTICS

$T_{amb} = 25 \text{ }^\circ\text{C}$ , unless otherwise specified

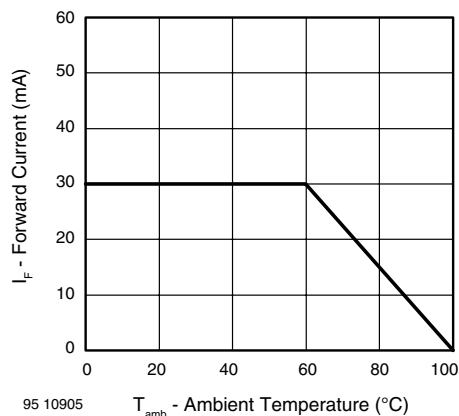

Figure 1. Forward Current vs. Ambient Temperature for InGaN

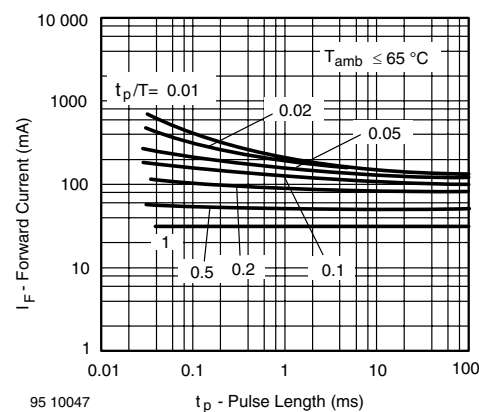

Figure 2. Forward Current vs. Pulse Length

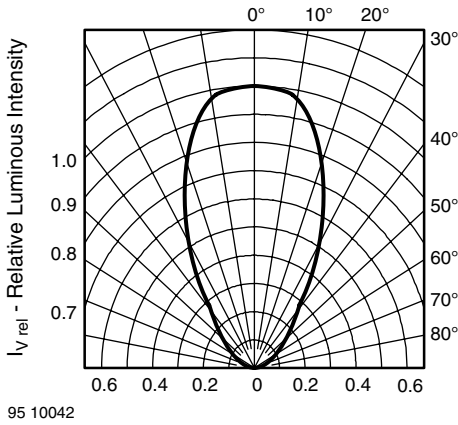

Figure 3. Rel. Luminous Intensity vs. Angular Displacement

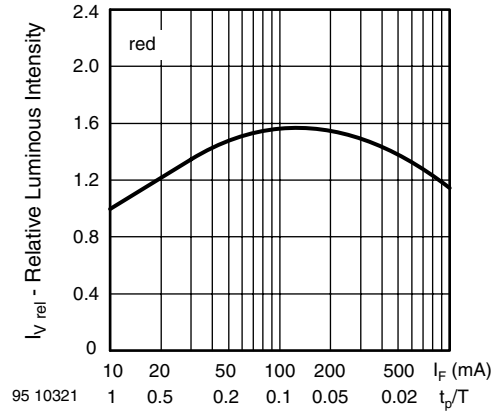

Figure 6. Rel. Lumin. Intensity vs. Forw. Current/Duty Cycle

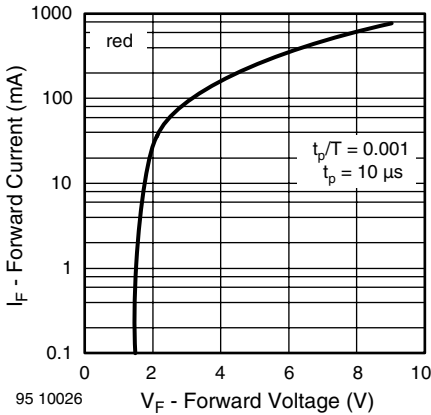

Figure 4. Forward Current vs. Forward Voltage

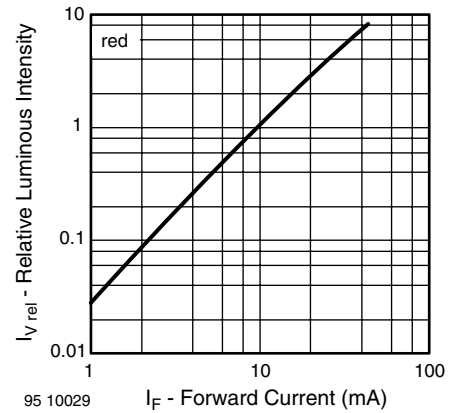

Figure 7. Relative Luminous Intensity vs. Forward Current

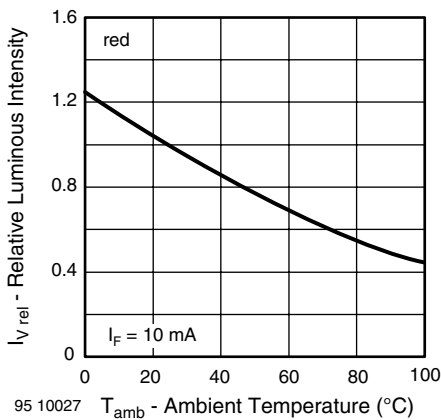

Figure 5. Rel. Luminous Intensity vs. Ambient Temperature

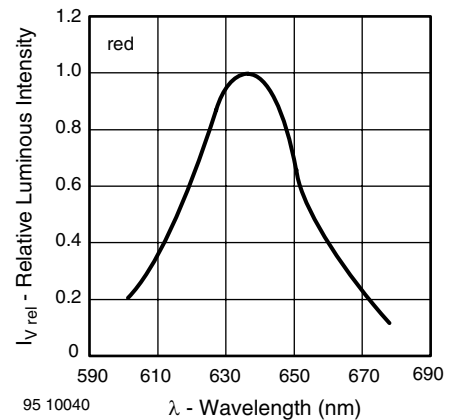

Figure 8. Relative Intensity vs. Wavelength

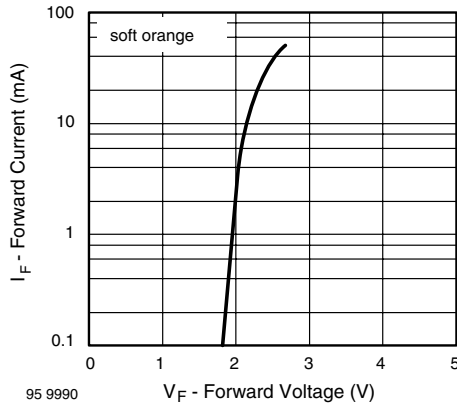

Figure 9. Forward Current vs. Forward Voltage

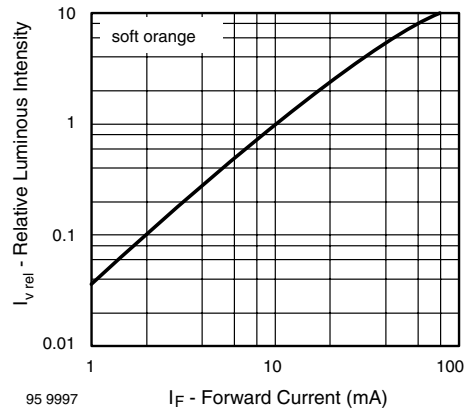

Figure 12. Relative Luminous Intensity vs. Forward Current

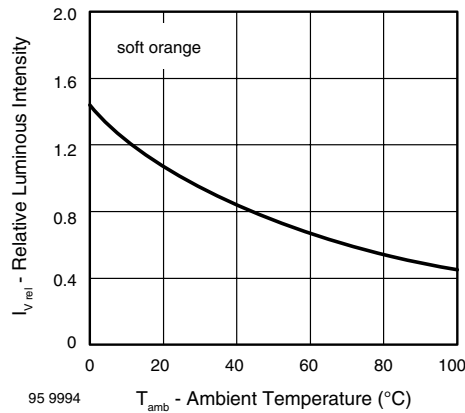

Figure 10. Rel. Luminous Intensity vs. Ambient Temperature

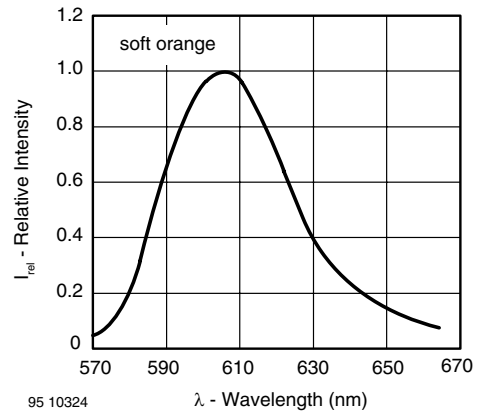

Figure 13. Relative Intensity vs. Wavelength

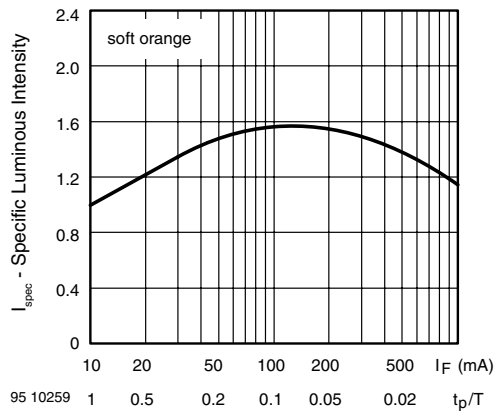

Figure 11. Rel. Lumin. Intensity vs. Forw. Current/Duty Cycle

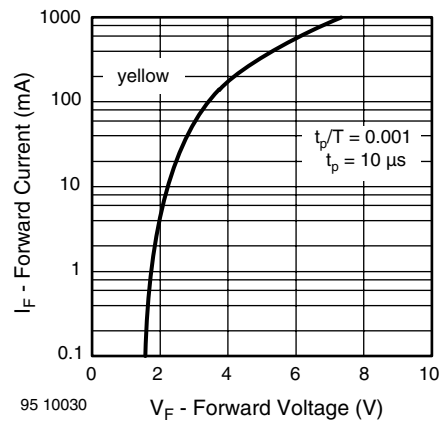

Figure 14. Forward Current vs. Forward Voltage

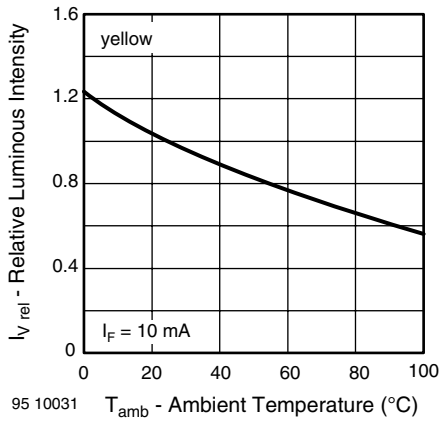

Figure 15. Rel. Luminous Intensity vs. Ambient Temperature

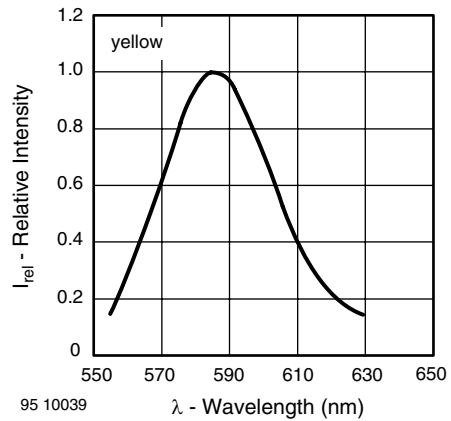

Figure 18. Relative Intensity vs. Wavelength

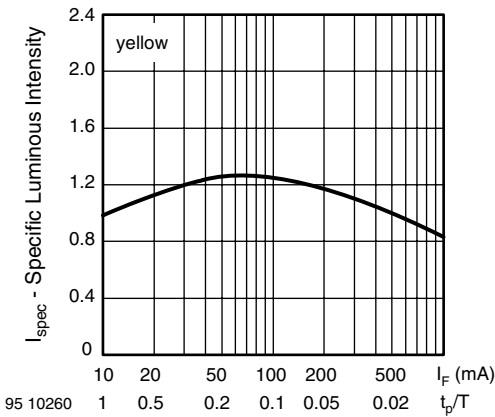

Figure 16. Rel. Lumin. Intensity vs. Forw. Current/Duty Cycle

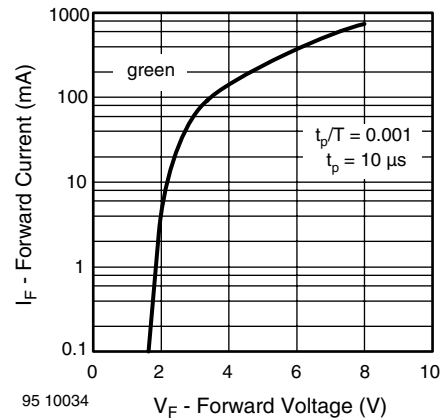

Figure 19. Forward Current vs. Forward Voltage

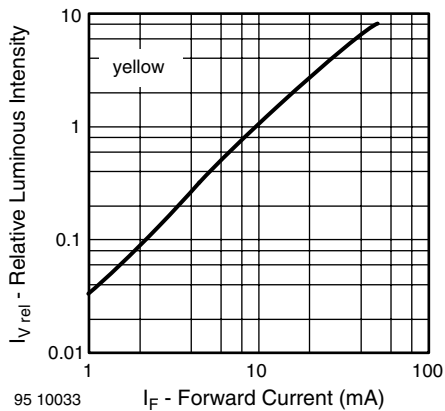

Figure 17. Relative Luminous Intensity vs. Forward Current

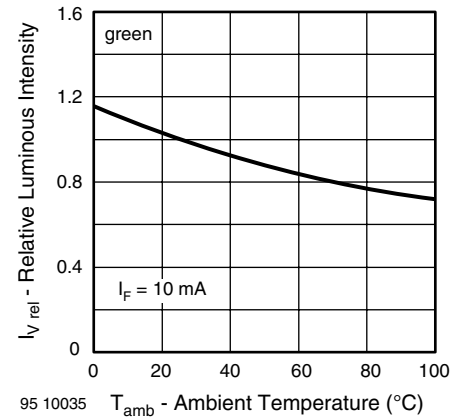

Figure 20. Rel. Luminous Intensity vs. Ambient Temperature

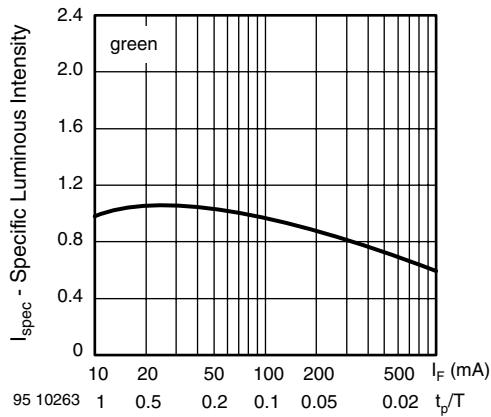

Figure 21. Specific Luminous Intensity vs. Forward Current

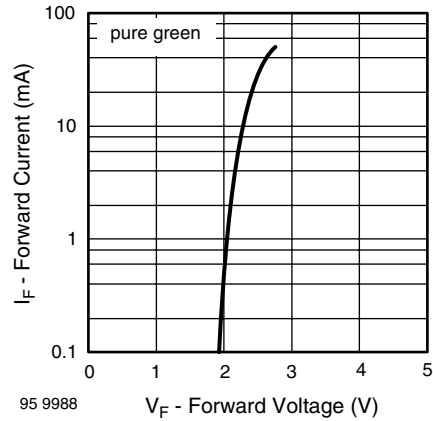

Figure 24. Forward Current vs. Forward Voltage

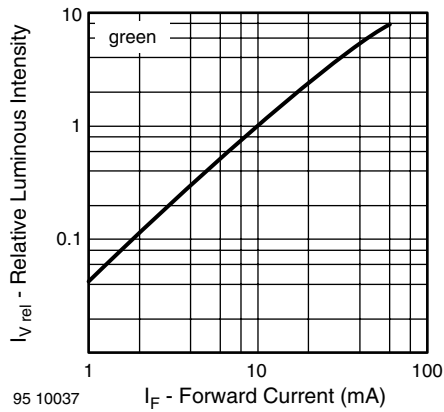

Figure 22. Relative Luminous Intensity vs. Forward Current

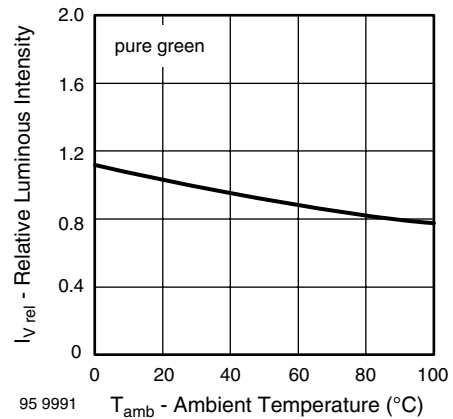

Figure 25. Rel. Luminous Intensity vs. Ambient Temperature

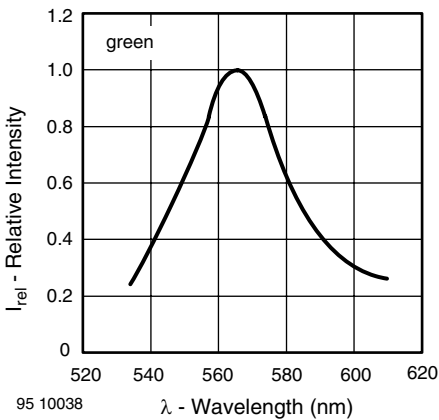

Figure 23. Relative Intensity vs. Wavelength

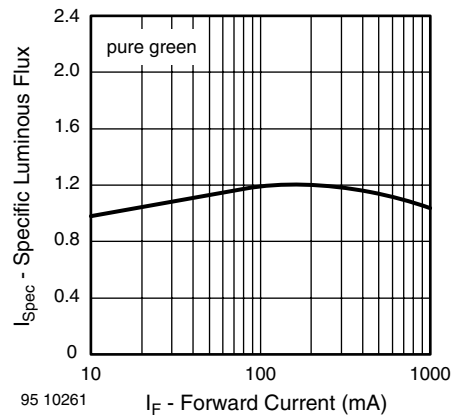

Figure 26. Specific Luminous Intensity vs. Forward Current



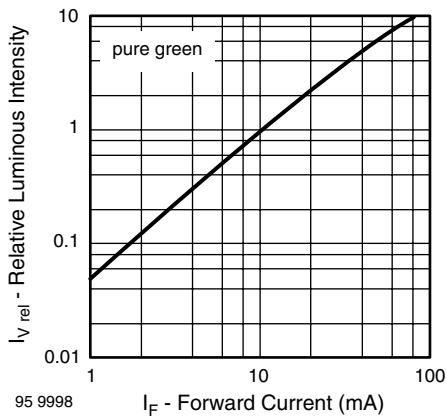

Figure 27. Relative Luminous Intensity vs. Forward Current

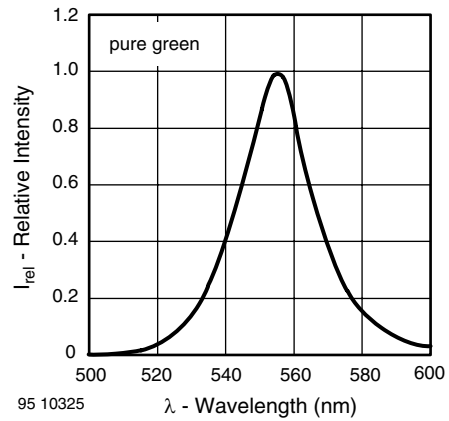
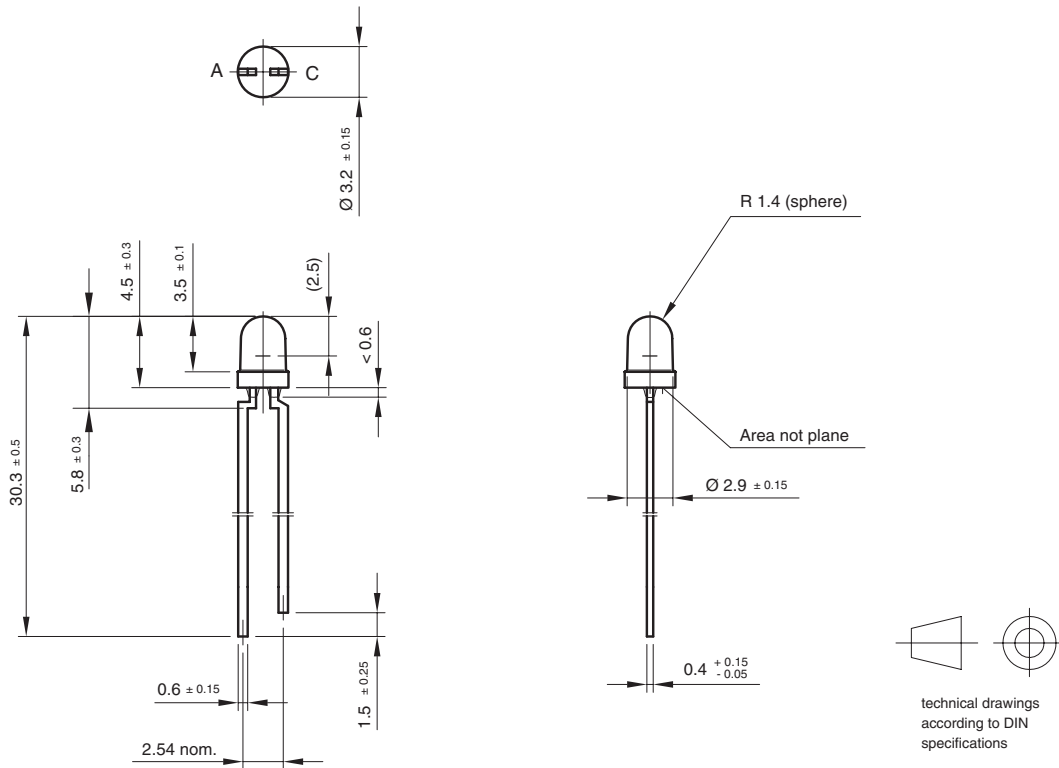

Figure 28. Relative Intensity vs. Wavelength

**PACKAGE DIMENSIONS** in millimeters



Drawing-No.: 6.544-5255.01-4  
 Issue: 7; 25.09.08  
 95 10913

**REEL DIMENSIONS** in millimeters

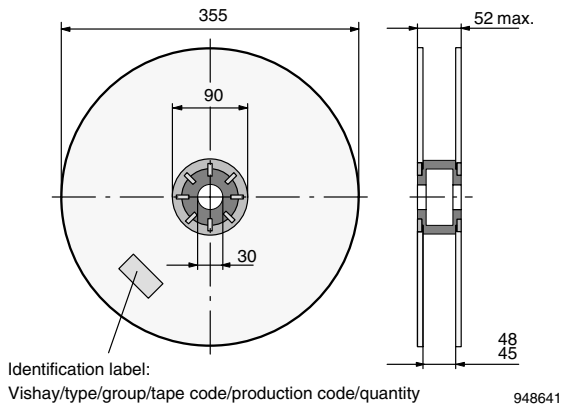

Figure 29. Reel

**AMMOPACK**

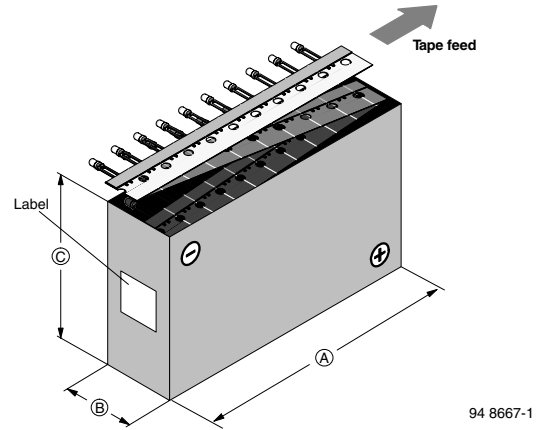

Figure 31. Tape Direction

**TAPE**

Note:  
AS12Z and AS21Z still valid for already existing types BUT NOT FOR NEW DESIGN

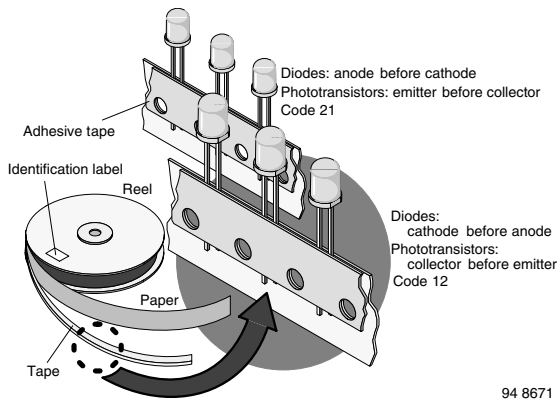
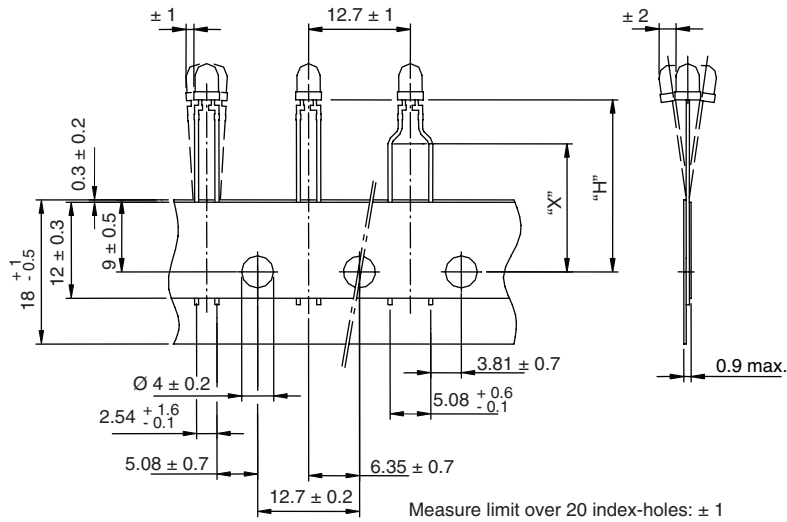

Figure 30. LED in Tape



**TAPE DIMENSIONS** in millimeters



Quantity per:	Reel (Mat.-no. 1764)
	2000

21885

Option	Dim. "H" ± 0.5 mm	Dim. "X" ± 0.5 mm
AS	17.3	
MS	25.5	
CS	22.0	
LS	21.0	
BT	20.0	16.0



## Disclaimer

All product specifications and data are subject to change without notice.

Vishay Intertechnology, Inc., its affiliates, agents, and employees, and all persons acting on its or their behalf (collectively, "Vishay"), disclaim any and all liability for any errors, inaccuracies or incompleteness contained herein or in any other disclosure relating to any product.

Vishay disclaims any and all liability arising out of the use or application of any product described herein or of any information provided herein to the maximum extent permitted by law. The product specifications do not expand or otherwise modify Vishay's terms and conditions of purchase, including but not limited to the warranty expressed therein, which apply to these products.

No license, express or implied, by estoppel or otherwise, to any intellectual property rights is granted by this document or by any conduct of Vishay.

The products shown herein are not designed for use in medical, life-saving, or life-sustaining applications unless otherwise expressly indicated. Customers using or selling Vishay products not expressly indicated for use in such applications do so entirely at their own risk and agree to fully indemnify Vishay for any damages arising or resulting from such use or sale. Please contact authorized Vishay personnel to obtain written terms and conditions regarding products designed for such applications.

Product names and markings noted herein may be trademarks of their respective owners.